



Sovitron Interior Pvt.Ltd.



Model Name	SILAS-K2101S Wall Light/ DL-OUC-K2101S-12
Description	Wall light (Indirect)

Technical description	Image
-----------------------	-------

Dimension	L=232mm W=210mm H=37mm
Frame	Aluminium Die-cast
Color Tempertaure	5700K
Power	12W
Total Luminous Flux	1020 lm
Efficacy	85 lm/W
IP rating	65
Beam angle	60°
Color Rendering	≥80
Mounting	Surface
Optics	Clear tempered glass
Dimming	NON-Dimmable
Operating Voltage	220-240 VAC
Standard Lifetime	L70 minimum at 50,000 burning hours



Dimension diagram

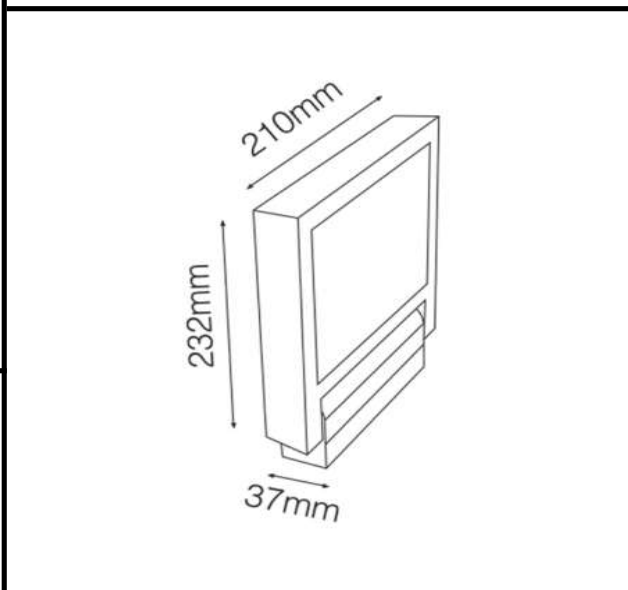

Remarks:-

Address: Plot #7 Saroorpur-Nangla Industrial Area,Ballabgarh-Sohna Road,Faridabad-121005
Email: info@sovitron.com